

balisa jm

by Jordi Miralles, Jordi Miró



Petra 1

balisa jm | 80 kg

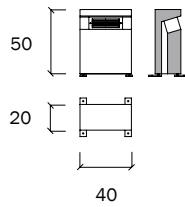

fontana

by I+D mago : urban



Petra 1

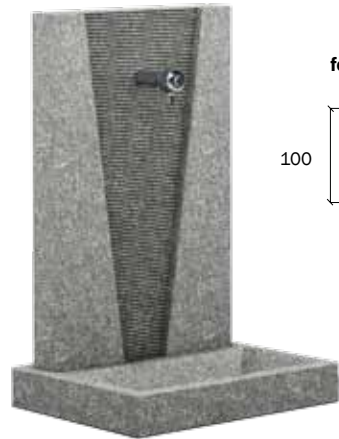

fontana | 95 kg

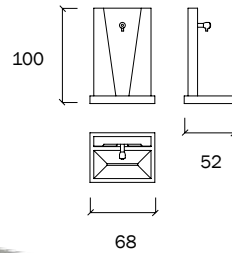

limitot

by Ton Riera



Petra 1

limitot | 283 kg

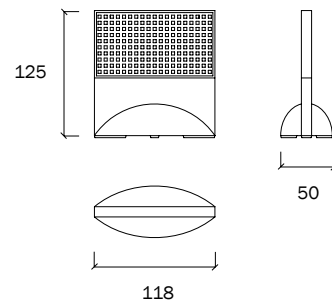

portable

by I+D mago : urban



Petra 1



portable R | 600 kg

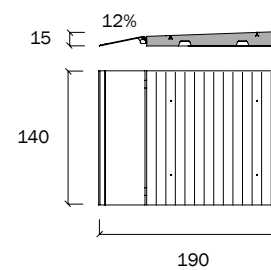

portable RI | 620 kg

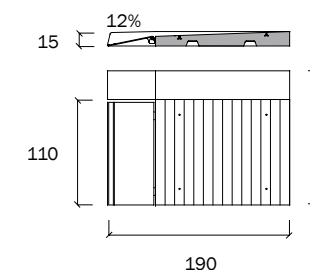

portable RD | 620 kg

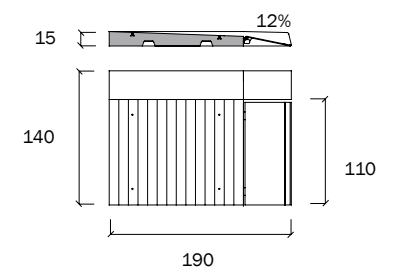

portable | 660 kg

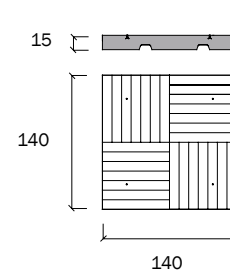

portable B | 250 kg

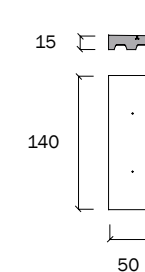

portable E | 65 kg

