

CARACTERISTICAS / FEATURES

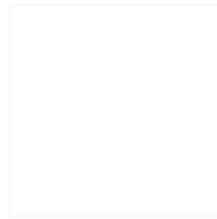

Material hormigón Petra 1 + madera
Acabado decapado e hidrofugado
Dimensiones l. 180, a. 49, h. 47 cm
Color ver carta de colores
Fijación apoyado por su propio peso o mediante varillas metálicas
Peso 116 kg
Palet 200 x 80 cm (5 un)

Material precast concrete Petra 1 + wood
Finish sanded and waterproofed
Dimensions l. 180, w. 49, h. 47 cm
Colour see colour catalogue
Fixing resting on the ground or with metal rod
Weight 116 kg
Pallet 200 x 80 cm (5 un)

diseñador / design: magourban

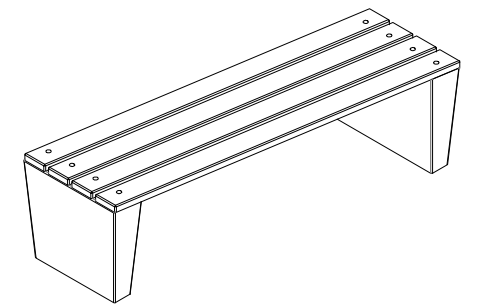

GEOMETRIA / GEOMETRY

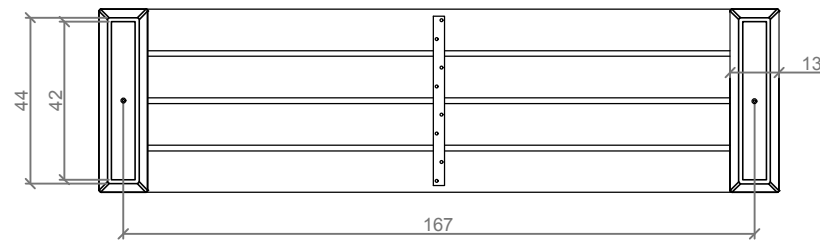

VISTA INFERIOR / BOTTOM VIEW



ALZADO / FRONT VIEW

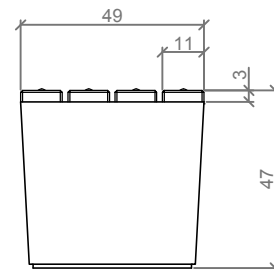

PERFIL / PROFILE

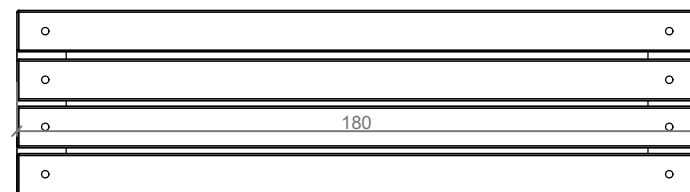

PLANTA / TOP VIEW

ESPECIFICACIONES / SPECIFICATIONS

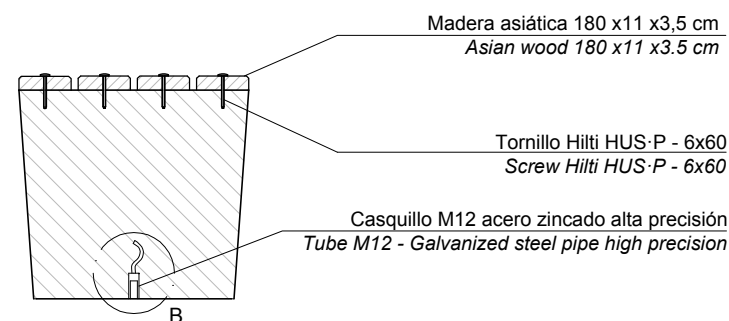

SECCION / SECTION

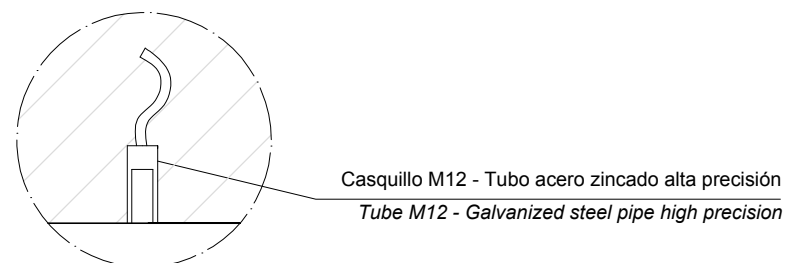

DETALLE B / DETAIL B

MANIPULACION E INSTALACION / HANDLING AND INSTALLATION

1 Enroscar la varilla
Thread the rod

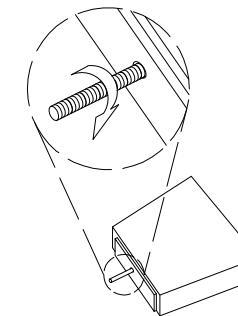

2 Perforar 2 agujeros a una distancia de 167 cm
Drill 2 holes each other at a distance of 167 cm

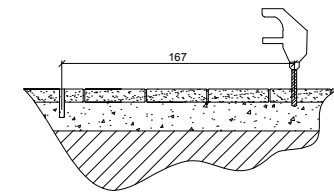

3 Verter resina epoxi / pour resin epoxy

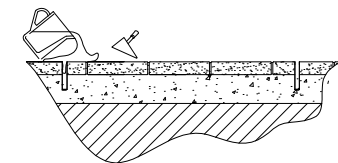

ATENCIÓN!!! DEBE INSTALAR LOS SOPORTES CON LA FLECHA ORIENTADA HACIA EL INTERIOR
ATTENTION !!! SHOULD INSTALL SUPPORTS WITH ARROW ORIENTED TO INSIDE

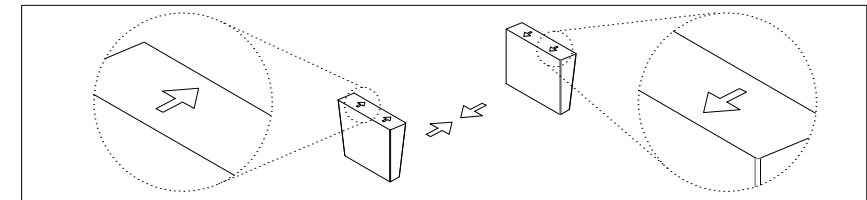

4 Insertar la varilla en el agujero
Insert metal rod in hole

Elevación / Hoisting
P= 50 kg

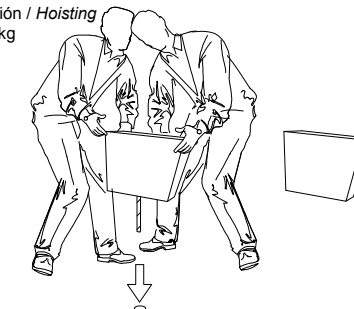

5 Instalar madera y fijar tornillos
Install wood & tightening screws

