

CARACTERISTICAS / FEATURES

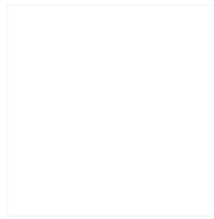

Material hormigón Petra 1
Acabado decapado e hidrofugado
Dimensiones l. 120, a. 120, h. 80 cm
Color ver carta de colores
Fijación apoyado por su propio peso o mediante resina epoxi
Peso 650 kg / 837 L
Palet 125 x 125 cm

Material precast concrete Petra 1
Finish scaled and waterproofed
Dimensions l. 120, w. 120, h. 80 cm
Colour see colour catalogue
Fixing resting on the ground or with epoxy resin
Weight 650 kg / 837 L
Pallet 125 x 125 cm

diseñador / design: magourban

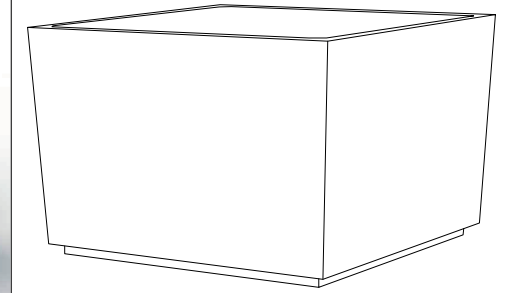
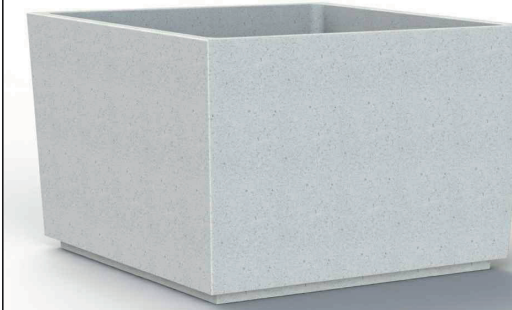

KONIQ JQ-120

GEOMETRIA / GEOMETRY

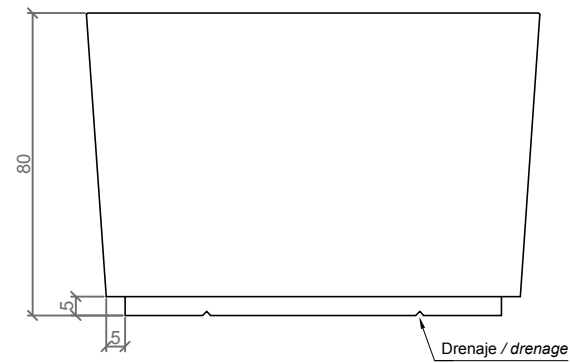

ALZADO / FRONT VIEW

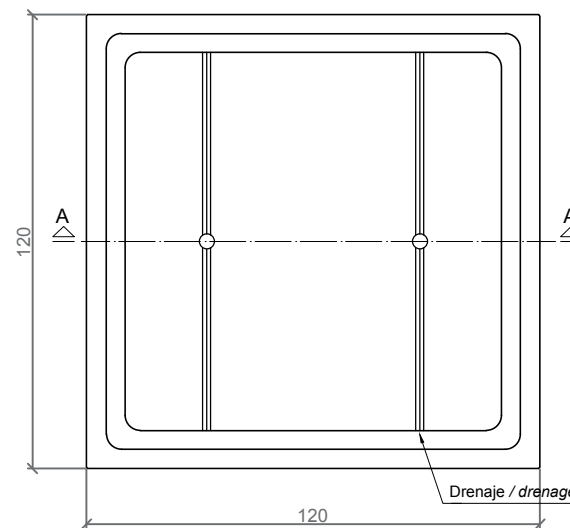

VISTA INFERIOR / BOTTOM VIEW

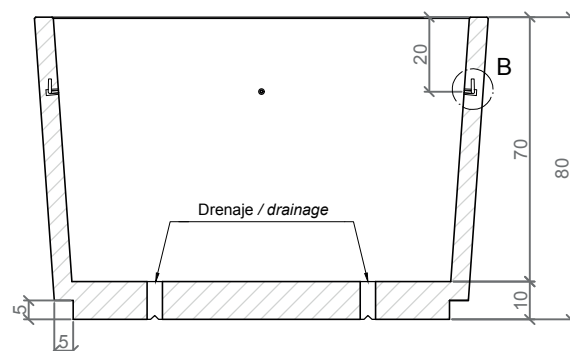

SECCION A-A' / SECTION A-A'

Casquillo M12
 Tubo acero zincado alta precisión
 Tube M12
 Galvanized steel pipe high precision

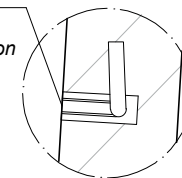

DETALLE B-B' / DETAIL B-B'

MANIPULACION E INSTALACION / HANDLING AND INSTALLATION

1 Enroscar cáncamo, fijar eslingas e instalar / Thread the eyebolt, fixing slings and install.

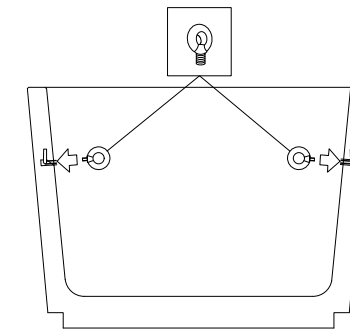

SOLO PARA DESCARGAR DEL PALET
 ONLY TO UNLOAD THE PALLET

Elevación / Hoisting
 P= 650 kg

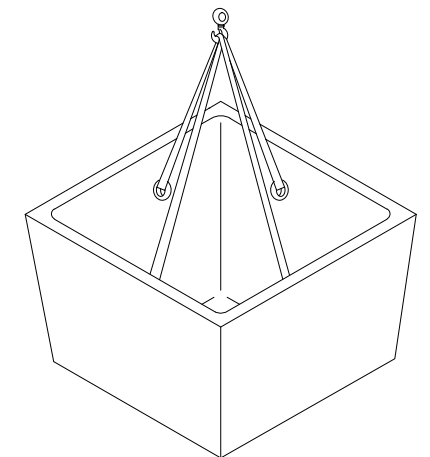

SISTEMA DE ELEVACION / ANCHORAGE SYSTEM

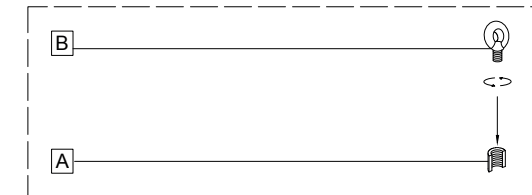

A casquillo roscado / threaded sleeve
 B cáncamo / eyebolt

ESPECIFICACIONES / SPECIFICATIONS

Tàrrega, Lleida - Tel. +34 973 15 87 03 - www.magourban.com - info@magourban.com

magourban

